

IconLift®

Superlative homelift for your home



MADE IN ITALY



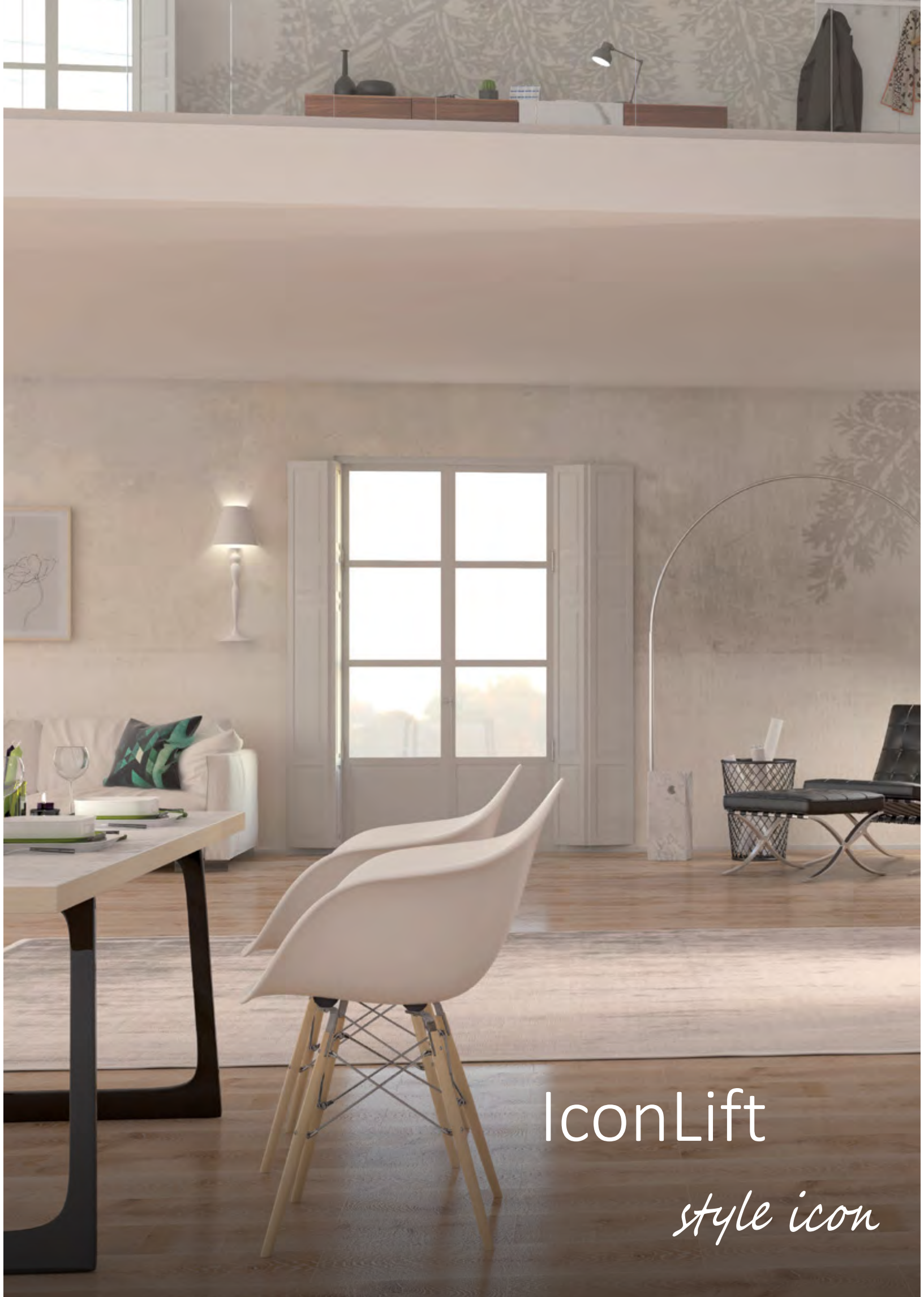

IconLift

style icon



Elegance and style

IconLift represents the homelift with a refined and elegant design. Thanks to its unique style it is suitable for any context, from classic to modern, contributing to the enhancement of every kind of environment.

Furnishing accessory

IconLift is the domestic lift brought to its highest level. From a functional object to part of the new living idea. The Italian interior design can now count on the IconLift elevator.

Made in Italy

Design doesn't just mean minimalism. It can have a strong or peaceful character, it can be histrionic or tactful but the Italian passion will always beat in its heart.

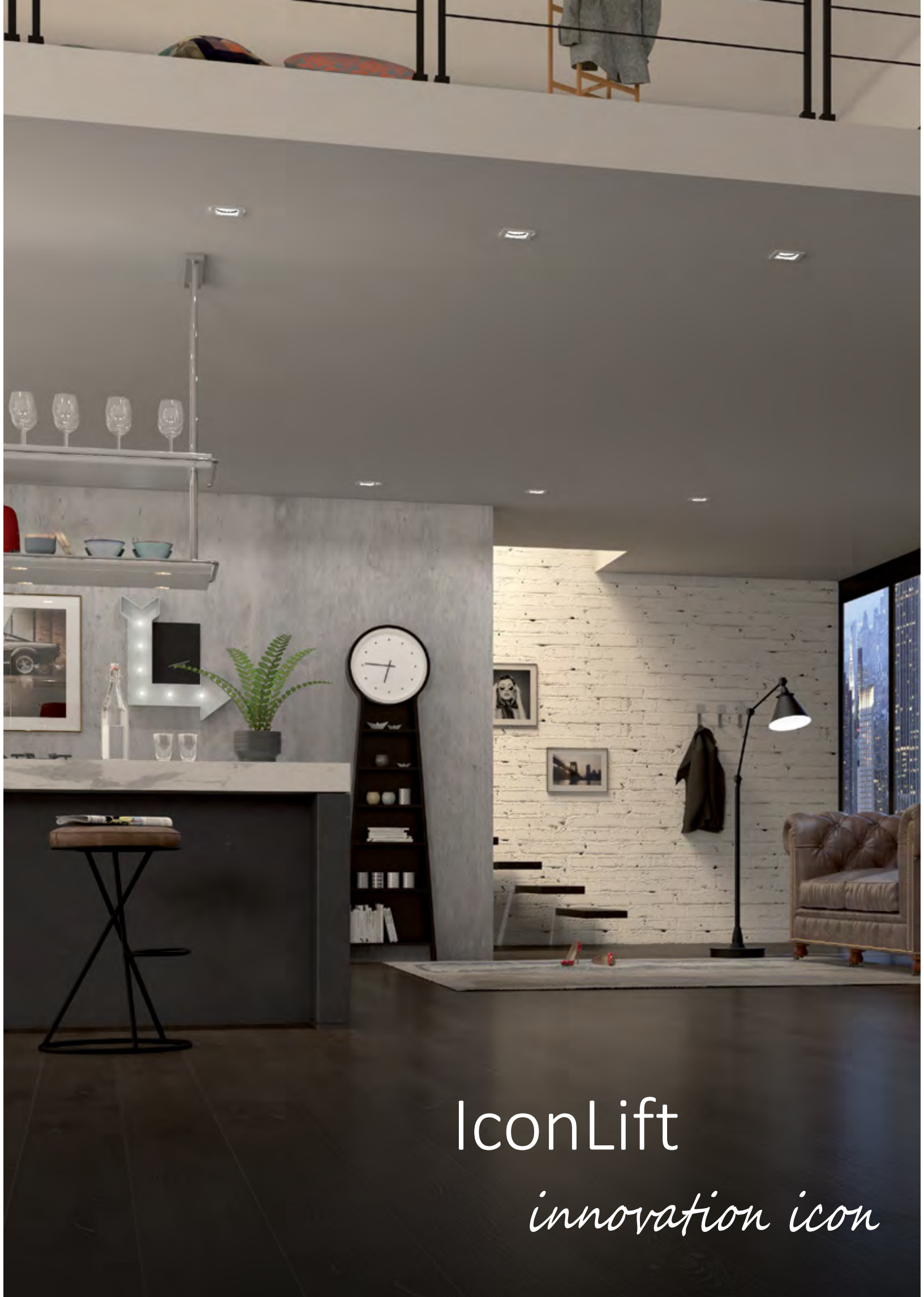

IconLift

innovation icon



Exclusive design

Unique in design, IconLift offers lines and angles of continuous light without any interruption, creating the perfect harmony between wall and ceiling.

Touch Screen

Just touch the Touch Screen or your smartphone to move in comfort and silence thanks to the safe, reliable, ecological oil-free electric motorization.

Full Optional

IconLift offers everything included: automatic doors, electric and silent traction, touch screen, dedicated APP for smartphones, design LED lighting. You just have to choose between the finishes we have selected for you.



IconLift

beauty icon



Functional beauty

The essential beauty of IconLift is given by the elements arranged in a sober, functional and intuitive way. The simplicity of use, safety at the highest level and the search for beauty represent the concept of a true Elevation Icon.

Environments

The cosmopolitan design has awesome shapes and colors. The large standard glazed walls, doors and continuous glass structure allows its integration in any environment.

Materials

Every detail has been thoroughly studied by our designers. Ceiling and the wall have the same material to give aesthetic continuity. They have been carefully selected to be placed in your home: IconLift will amaze you.

IconLift

style guide



Caucaso

Modern finish with concrete effect

*Strong character of firmness,
modern and of sure tendency*



Chocolat

An intense and passionate color

Warm, innovative and captivating

Made in Italy, world heritage

Our home lifts are more than just a lift.

They represent authentic Made in Italy, made of culture, history, wisdom and values.

From fashion to cooking, from artworks to sport cars: Made in Italy is an icon in the world.



Satin gold

The satin finish provides refinement on the surface of the noble metal



Vulcano

A modern tone and actualized thanks to the surface of volcanic rock

Powerful and intense

IconLift

style guide



Satin steel

A modern classic to reflect light
in a specular and widespread way

*Technological
and always cool*



Zebrano wood

A characteristic and modern wood

Unique and unmistakable

Lifestyle

We express our culture through our IconLift.

Search for beauty, technology, comfort: IconLift is Italian art in motion.

It's a choice. It's a lifestyle.



Shiny gold

The most appreciated precious color
with an irresistible charm

Gold is the color of the sun: light, warmth and vitality



Polished gunsteel

A color that never fades

*Thanks to its several nuances
it gives a relaxing
and elegant atmosphere
to every spot*

IconLift

lifestyle

Small elevators for private houses

Our homelifts find their natural location in private houses to let you **fully experience your home environments**. IconLift requires a **minimal space** to be placed within the walls of the house. You can take advantage of every corner of your home thanks to the customizable dimensions with a 10 mm pitch.



Automatic control

Thanks to the closed car on all four sides, IconLift guarantees automatic control as standard: simply select the button of the wished floor and **you will move without pushing the button**. However, the exclusive IconLift patent includes the possibility of moving with a hold-to-run operation.

Indoor homelift

IconLift elevators have been designed specifically for the interior of your home: **minimally invasive structures, extensive use of glazed surfaces to ensure transparency and brightness**.

Closed car

An exclusive advantage of IconLift is to travel safely in a closed car. It guarantees great comfort thanks to a **gentle movement with soft starts and stops**.



Automatic doors at landing floors

IconLift platforms have standard **automatic glass-swing doors** which guarantee a remarkable aesthetic impact, maximum transparency, visibility and passive safety.

Unlike automatic sliding doors, automatic swing doors do not need any space at side, **optimizing every single centimeter**.

We offer two types of car entrances: single, which means entering and exiting from the same side, or through entrances providing the exit on the opposite side.

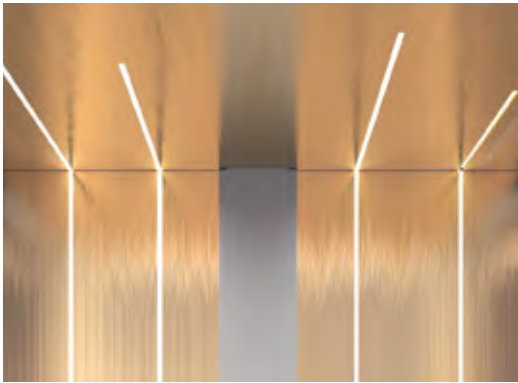

Full optional at the same price

IconLift does not need a list of options: everything a homelift can offer is included. Electric motorization, automatic doors, touch screen, APP... everything is given as standard.

You will only have to choose between the charming and selected finishes.

Choose what you want: the price stays the same!

Full glass structure

IconLift is supplied in an anti-seismic steel supporting structure. This element has been carefully designed. It is offered with the **exclusive full-glass structure for all its height!**

This solution is enhanced with the use of smoked glass.



Safety

IconLift guarantees maximum travel safety because it is closed on all sides including the entrance side thanks to manual double swing glass doors. The wide range of safety devices includes:

- ☞ emergency button
- ☞ overload device
- ☞ telephone dialer
- ☞ alarm signal
- ☞ door and lock opening control
- ☞ emergency light
- ☞ infrared light curtains
- ☞ automatic lowering to the floor in the event of blackout
- ☞ control panel supply with emergency buttons

Never worry again to get stuck in a car.

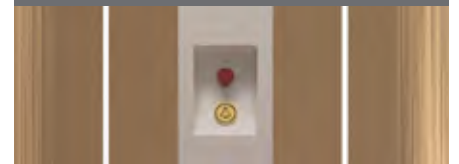

Easy to install

IconLift does not require masonry works or bulky ramps: the pit is only 50mm. It is possible to install on the existing floor. It takes **only take two or three days** to get your IconLift working.

It takes up a minimum space

Thanks to its technology, IconLift can be installed within a minimal space.

We leave more space in your home as IconLift does not require any machine room or cabinet to contain the motor: IconLift includes everything inside the installation spaces.
MRL - Machine Room Less!

Technology

IconLift is activated **by touching the touch screen** in the car, by an APP on your smartphone or by pushing the button.

IconLift APPs **will constantly monitor your homelift.** In case of need it is possible to **remote resetting** it.

The **electric** screw driven system ensures reliability, durability, smooth movement, quietness and takes care of the environment since it does not require the use of oil.

IconLift

finishes

Walls and ceiling

"Prestige Collection" HPL laminate



549
Caucaso - Concrete effect

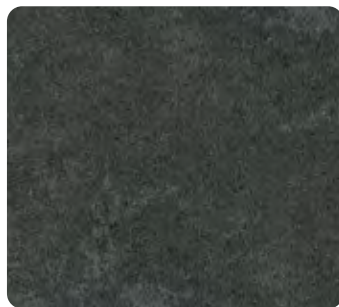

545
Vulcano



1388
Zebrano wood

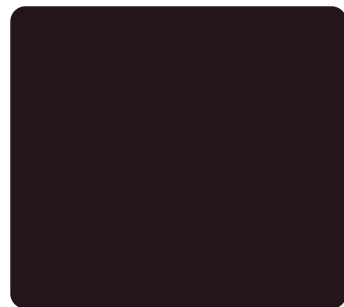

1870
Chocolat

Walls and ceiling

"Steel and Gold Collection" HPL laminate

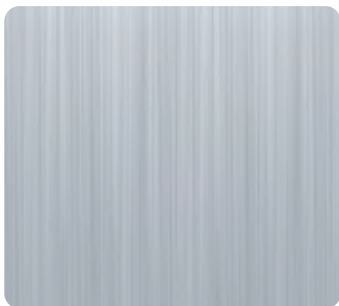

727
Satin steel



726
Polished gunsteel



874
Satin gold



881
Shiny gold

Floors

"Eternal Collection" PVC flooring

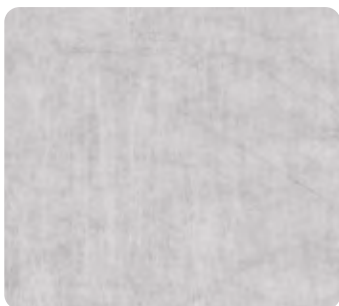

13772
Eternal Brushed Aluminium

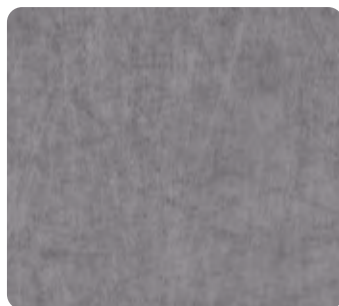

13712
Eternal Brushed Chrome

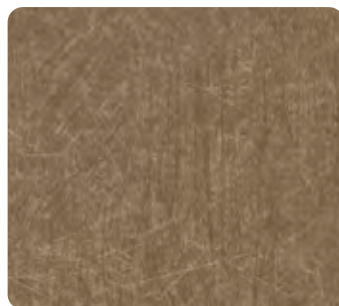

13762
Eternal Brushed Bronze



42292
Eternal Charcoal Slate

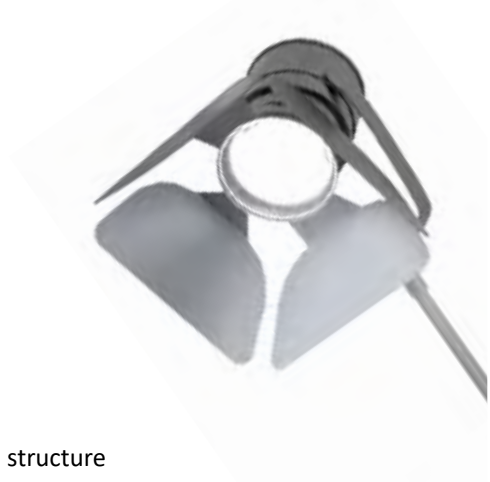

Stainless steel

For push-button panel and car profiles



Scotch Brite
Stainless Steel



Mirror
Stainless Steel

Glasses

For landing doors and steel structure



Natural

Smoked Grey

Smoked Bronze

Powder painting

For steel structure, COP, car profiles and landing doors

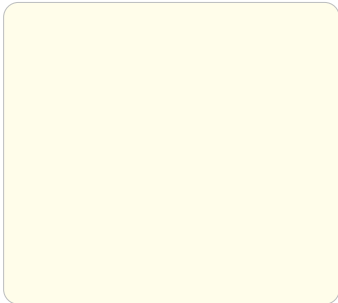

RAL 9010
Pure white



RAL 9007
Grey aluminium

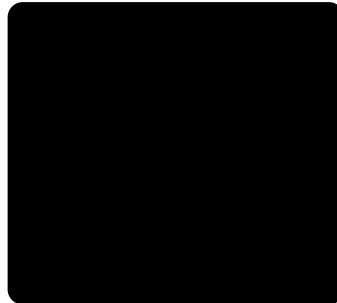

RAL 9005
Jet black

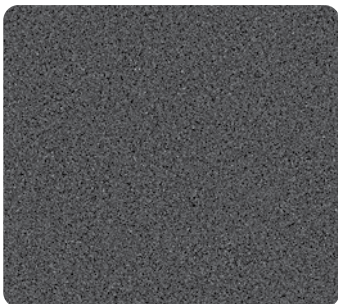

GREY MICA
Grey mica

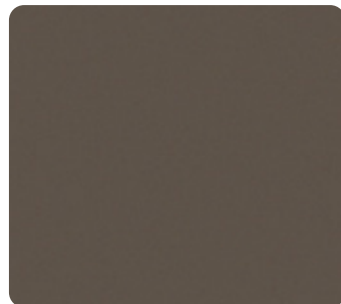

BRONZE 2525 - YW283 F
Bronze



GOLD 2525 - YW106 I
Gold

IconLift

standard equipment



- Panoramic supporting structure (with glass of your choice)
- Automatic landing doors
- Car doors (version without car doors available for extra EU countries and for EU countries with hold-to-run operation only)
- Ceiling
- Lighting with LED strips
- Wall and ceiling with same finishes
- COP with touch screen
- Panoramic car walls with transparent glass
- Floor

Ceiling and lighting

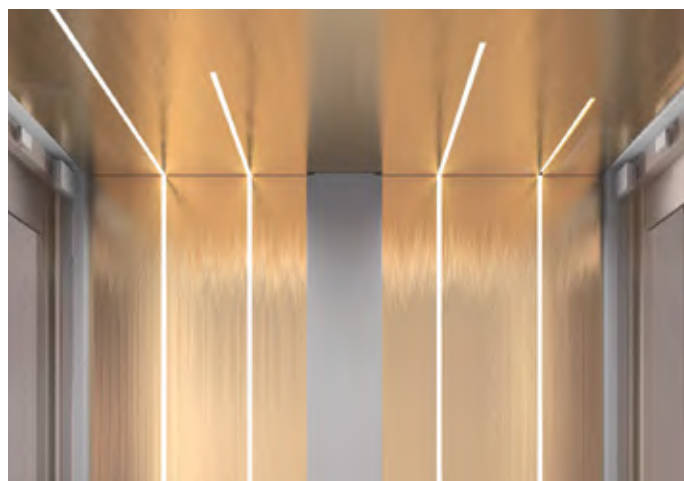

Continuous LED lighting strips between ceiling and wall.
 ☞ Ceiling finish: same as walls, chosen from HPL "Prestige Collection" and "Steel and Gold Collection".

Landing and car doors



Double swing landing doors in laminated glass; fully automatic opening and closing.
 ☞ Landing doors finishes: glass choice in combination with the set-up painted with the same color as the structure.

Manual double swing **car doors** in laminated glass with glass handles.

☞ Cabin door finishes: transparent glass.



COP

Full height COP
with touchscreen keypad.
Alarm and stop buttons
set in a special niche.

- 🔗 COP finishes to choose between stainless steel and powder coating
- 🔗 Width 250 mm

Standard configuration

- 🔗 Touch screen control panel
- 🔗 Overload acoustic and light signals
- 🔗 Alarm button
- 🔗 Emergency stop button
- 🔗 Emergency light
- 🔗 Two-way interphone
- 🔗 Phone dialer

LOP

- 🔗 On door frame



Type of Buttons

- 🔗 Control buttons (Ø 29.6 mm) with Braille indication
- 🔗 Matt stainless steel finish
- 🔗 Round ring in glossy finish (Ø 36.8 mm)
- 🔗 White backlighting



APP

- 🔗 Remote landing call
- 🔗 Landing call planning
- 🔗 Advanced diagnostic system
- 🔗 Detailed reporting of all functioning and failures in the homelift
- 🔗 Alarms to be managed remotely

IconLift

data sheet



Indoor



Suggested use



Max payload



230 VAC
single phase

General features

Load/capacity	Up to 400 kg / 5 persons
Travel	Up to 12 m
Entrances	1 - 2 opposite
Stops (in line)	Up to 5
Speed - Max	0,15 m/sec (9 m/min)
Operation	Automatic and hold-to-run button
Noise level	47 dB max
Headroom	2300 mm min
Pit	50 mm
Runs/Hour suggested	15 max
Power supply	Single phase 230 Vac
Electrical control panel	Serial type controller on-board
Reference Standards	D.M. 2006/42/CE - EN81.41

Shaft

Self supporting anti-seismic structure	Painting at choice
Shaft cladding	Glass at choice

Car

Screw side wall	Laminate HPL finishes at choice
Other walls	Panoramic transparent glass walls
Minimum car dimensions	660 mm (L) x 900 mm (P)
Maximum car dimensions	910 mm (L) x 1300 mm (P)
Car height	2050 mm
Customized dimensions	10 mm step

Car and landing doors

Double swing manual full glass car doors	Transparent glass
Double swing automatic full glass landing doors	Glass and powder painting at choice
Clear opening (PL x LH)	Min. 600 - Max 750 x LH 2000 mm

Traction

Traction type	Screw and nut driven electric MRL
---------------	-----------------------------------

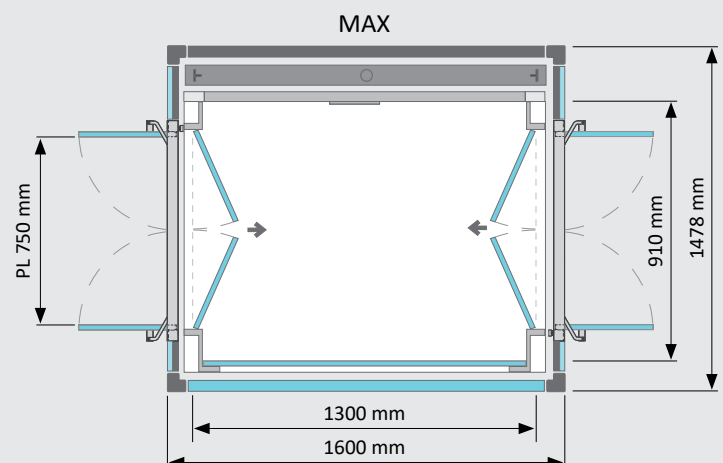
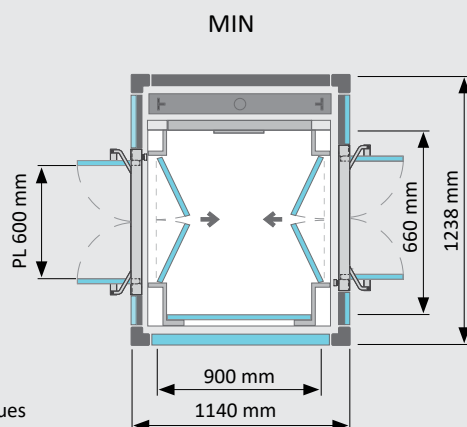

Reference values
not simultaneous

IconLift

superlative homelift

www.liftingitalia.com



Who we are

LiftingItalia is a young company established by professionals with long experience in the vertical transport sector.

LiftingItalia is specialized in the design and production of home and platform lifts to overcome differences in height up to 20 meters.

Our products are sold in over 30 countries worldwide!

Made in Italy

What makes us unique is the Italian style and the attention to quality which comes from our history as a manufacturing company.

Functional and comfortable, LiftingItalia's homelifts allow you to move easily, in perfect autonomy and with the charm that distinguishes the Italian style.

LiftingItalia and AreaLift

The group consists of two young and dynamic companies that work in perfect synergy completing each other.

LiftingItalia - Established in 2003, is the parent company and today is specialized in the production of **high quality homelifts**.

AreaLift - Established in 2006, is a company **specialized in accessibility solutions and vertical mobility**.



LIFTING ITALIA S.r.l.

Via Caduti del Lavoro, 16
43058 Bogolese di Sorbolo - Parma, Italy
Tel. +39 0521 695311

www.liftingitalia.com



Auckland, New Zealand
09 808-6036 (Option 1)
enquiries@mcgrath.co.nz
www.mcgrath.co.nz